

INSTALLATION / SOLID PLASTIC (HDPE)



DOOR HARDWARE KITS

8" ALUMINUM WRAP AROUND HINGE

HINGE

Hinge kit will contain aluminum housings and toothed plastic inserts. Plastic cam (#3) will be inserted into one of the aluminum housings (#1). This will be the bottom half of the top hinge (pilaster side). Insert female plastic insert (#4) into an aluminum housing. This will be the top half of the upper hinge (door side). To set closing position of door, mate toothed cam into aluminum housing until desired setting is achieved.

Insert non-cammed hinge pin (#2) into an aluminum housing. This will be the top half of the lower hinge (pilaster side). The remaining female plastic insert should be placed into aluminum housing and coupled with the other half of the hinge. Proceed to mark door and secure hinges to edge of pilaster and door with flathead screws (#11) with the exception of the bottom door hinge. This will be secured after the door is hung on the pilaster. Through-bolt all holes with provided step bolts and barrel nuts.

LATCH & BUMPER

Install slide latch at midpoint of the door, 27 1/2" inches up from the bottom of the door. Beveled side should face up to allow for emergency access when door is lifted.

Mount the slide latch on to the door with two step bolts and two barrel nuts. Install keeper and bumper on pilaster. Be sure that the keeper and bumper is set so that the slide bar of the slide latch engages the notch of the keeper. Install keeper/bumper with three step bolts and three barrel nuts.

PART ID.	Description	Qty
1	4" Aluminum housings	(4)
2	Top hinge plastic male insert	(1)
3	Bottom hinge cammed insert	(1)
4	Female plastic insert	(2)
5	Stop and keeper	(1)
6	Slide latch	(1)
7	Vandal resistant SS step bolts	(21)
8	Vandal resistant SS barrel nuts	(21)
8	Bumper and coathook	(1)
10	Vandal resistant SS screw	(2)
11	Flathead SS screw	(4)

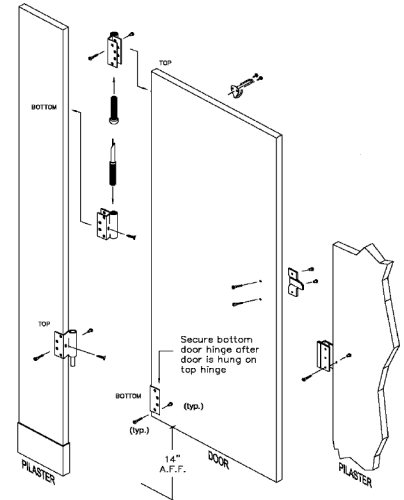

VAULT HINGE

HINGE

Locate and set pilaster hinge bottom to pilaster. Locate and set vault hinge bottom & top door side using step bolts and barrel nuts. Place bushing in top door hinge. Place door in bottom pilaster hinge. Secure with cam, washer and nut. Locate and set vault hinge top pilaster side.

LATCH & BUMPER

Install slide latch on door opposite the hinge side of the door. Slide latch should be mounted at midpoint of the door. Install keeper and bumper on pilaster. Be sure that the keeper and bumper is set so that the slide bar of the slide latch engages the top notch of the keeper.

EMERGENCY ACCESS

Lift door causing latch bolt to clear keeper and open.

PART ID.	DESCRIPTION	QTY
1	Vault hinge top pilaster side	(1)
2	Vault hinge top door side	(1)
3	Vault hinge bottom door side	(1)
4	Vault hinge bottom pilaster side	(1)
5	Spacer (phenolic only)	(1)
6	Spacer (phenolic only)	(1)
7	Spacer (phenolic only)	(2)
8	Cam adjusting bottom hinge	(1)
9	Bushing nylon top hinge	(1)
10	Nut adjusting bottom hinge	(1)
11	Hinge washer internal	(1)
12	Slide latch brushed finish	(1)
13	Inswing keeper brushed	(1)
14	Vandal resistant SS barrel nut	(10)
15	Bumper and coathook	(1)
16	Vandal resistant SS barrel nut	(1)
17	Vandal resistant SS step bolt	(11)
18	Vandal resistant SS screw	(2)

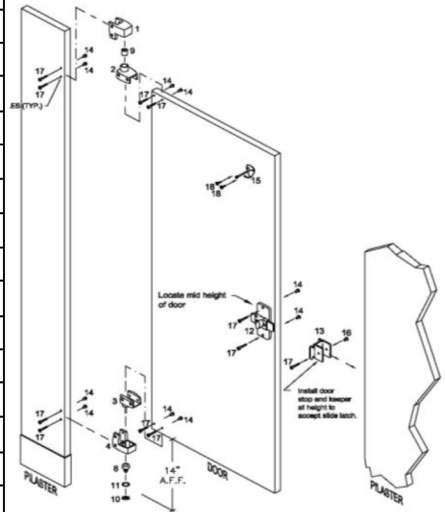

INTEGRAL HINGE

- Insert bottom integral hinge cam side into door with high/low points parallel with door. See figure 1. Pin unit to door by drilling #25 (.1495) dia. Hole a minimum of 1.75" deep through edge of door and hinge as noted on dwg. Lock edge of door and hinge lock unit into place with cap point set screw. See figure 2.
- Insert bottom integral hinge pin side into pilaster. See figure 3. Set door over bottom hinge. Hold door at an in tilt. Insert top integral hinge into hole at top of pilaster. See figure 4. Align door and let top pin fall into hole at top of door. See figure 5. Door is hung.
- Set door position. Closed for outswing door, open for inswing door. When door position is set, drill #25 (.1495) dia. hole a minimum of 1.75" deep through the pilaster edge and hinge at bottom. Lock hinge into place with cap point set screw. See figure 6.
- Drill #25 (.1595) dia. hole a minimum of 1.75" deep through both top hinge and door. Lock top pin into place using cap point set screw. See figure 7.

PART ID.	DESCRIPTION	QTY
1	Top integral hinge pin nylon	(1)
2	Bottom integral hinge cam side nylon	(1)
3	bottom integral hinge pin nylon	(1)
4	Slide latch brushed finish	(1)
5	Door stop & keeper brushed finish	(1)
7	Bumper and coathook	(1)
8	Vandal resistant SS step bolt	(6)
9	Vandal resistant SS barrel nut	(6)
10	Vandal resistant SS screw	(2)
11	Cap point set screw (phillips head)	(4)
12	Spacer door stop	(1)

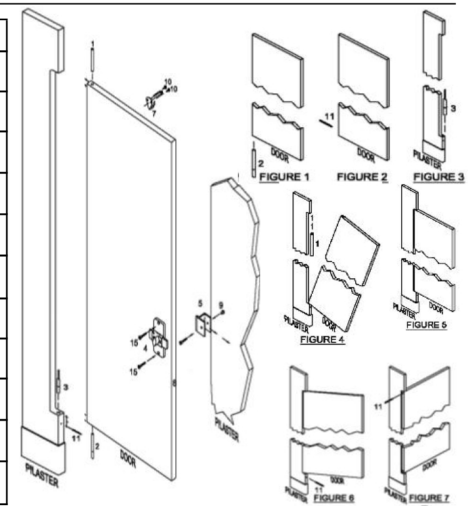

INSTALLATION / SOLID PLASTIC (HDPE)

OVERHEAD BRACED

STEP 1 LAYOUT FLOOR ANCHORED/OVERHEAD BRACED

NOTE:FLOOR MUST BE CONCRETE

- Review the layout drawings and package lists that have accompanied this job.
- Before proceeding, confirm that backing of walls and floor is adequate to support secure mounting of the toilet compartment units.
- Establish and mark pilaster center line from back wall.
- Establish and mark panel center lines for wall brackets.
- Establish pilaster floor fastener locations from side wall according to shop drawings. (Note floor fasteners are located 1" from edge of pilaster.)
- Mark wall bracket holes using brackets as templates.

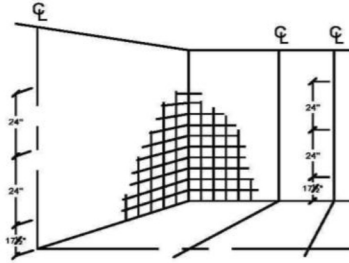

STEP 2 WALL BRACKETS AND FLOOR ANCHORS

- Drill holes for wall brackets and floor anchors of appropriate size for particular fastening devices supplied. Typically, 5/16" bit for walls, 1/4" bit for compartment thru-bolts, and 3/16" bit for floors. (Note: As site conditions and hardware combinations vary, an assortment of bit sizes are recommended.)
- Insert anchoring devices in walls and secure wall brackets.
- Attach the shoes to the concrete floor using the 1/4" concrete screws. (Note: The hole in the side of the shoe should be placed on the inside of the compartment.)
- Adjust the location of the shoes according to the door opening size and secure shoes to the floor.

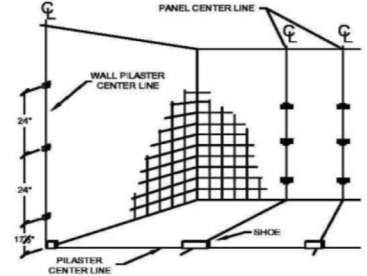

STEP 3 POSITION PANEL

- Place panel on a support, 14" above the floor.
- Set it into wall brackets, but do not fasten panel at this time.

NOTE: Metal heat-sink strip will be on bottom of panel

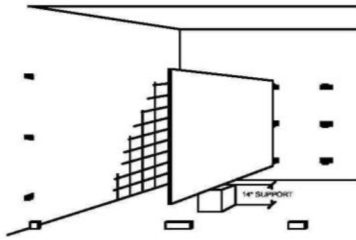

STEP 4 PILASTER PREPARATION

- Align brackets in position on rear of pilasters. Refer to layout drawings.
- Fasten brackets to pilaster with sheet metal screws.
- Pilasters at wall will not have U-brackets, but should be prepared for wall (and floor fastening) as required by compartment layout.

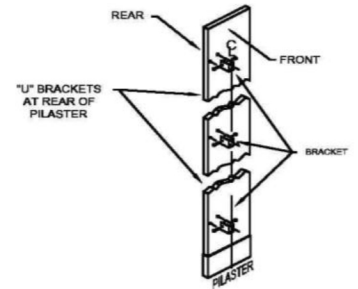

STEP 5 INSTALL PILASTERS

- Insert the leveling bolt into the threaded insert the bottom of the pilaster.
- Insert the pilaster into the shoe.
- Level the top of all pilasters by adjusting the leveling bolt to desired position.

Note: To determine how far to insert the leveling bolt, find the highest point on the floor, and fully insert the bolt on the pilaster that will be mounted in that location. Adjust all other leveling bolts accordingly.

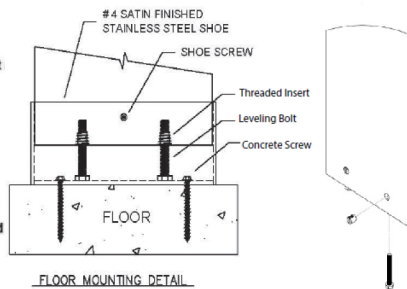

STEP 6 SECURING PILASTER/PANEL

- Level the panel and adjust the gaps at either end.
- Secure the panel to the wall and pilaster using through bolts.
- Remove panel support device.
- Plumb each pilaster and secure with headrail. (See headrail detail below.)
- Secure the pilaster to the shoe using shoe screws.

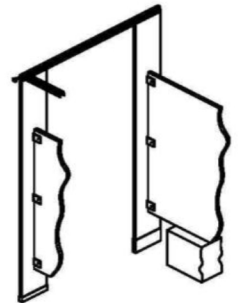

STEP 7 INSTALL DOORS

EMERGENCY ACCESS
Lift door causing latch bolt to clear keeper and open.

- See the door hardware kits section for the appropriate hinge type.
- Install slide latch on door opposite the hinge side of the door. All slide latches should be mounted at the mid point of the door.
- Install the stop and keeper on the pilaster so that the top of the stop and keeper is no more than 1/4" above the bottom of the slide bar on the slide latch.
- For emergency access lift the door so that the slide latch clears the stop and keeper and open the door.

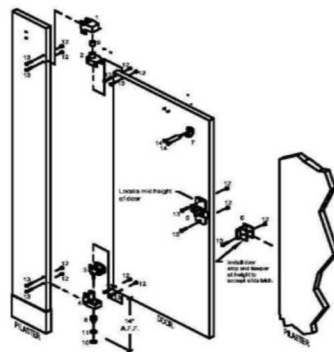

HEADRAIL DETAIL

EXPLODED ASSEMBLY

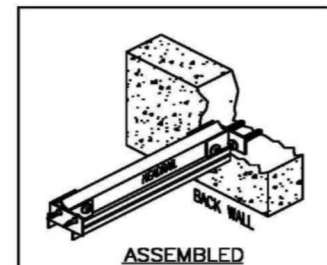
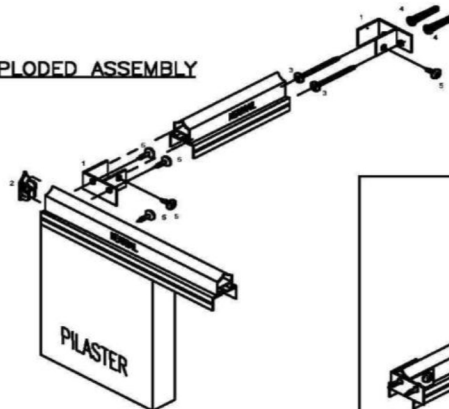

INSTALLATION / SOLID PLASTIC (HDPE)

FLOOR AND CEILING

1 INSPECTION

The components for this project have been custom fabricated. They are guaranteed with respect to manufacture and workmanship and were inspected at the factory. Before beginning work, the units should be inspected. If damage occurred in transit, report immediately to the freight company or other agencies that may have caused the damage.

4 POSITION PANEL

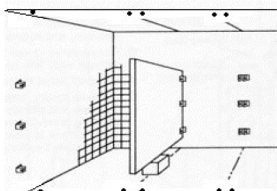

- Place panel on a support 14" above the floor.
- Set it into wall brackets but do not fasten panel at this time.

8 DOOR ASSEMBLY AND HANGING

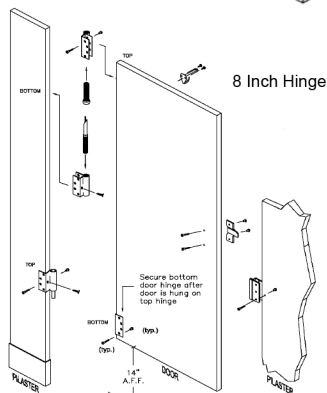

10 MISCELLANEOUS HARDWARE

- Install door bumper (and hook) in proper position.

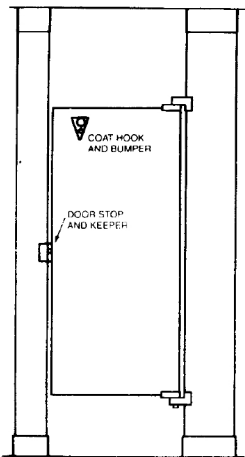

2 LAYOUT

NOTE: FLOOR MUST BE CONCRETE

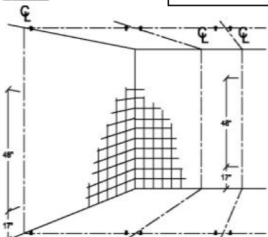
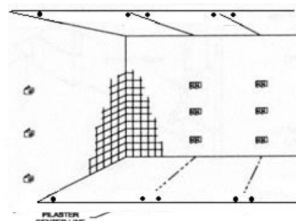

FIGURE 1.

- Review the layout drawings and package lists that have accompanied this job.
- Establish and mark pilaster center line from back wall.
- Establish and mark panel center lines for wall brackets.
- Establish pilaster floor anchor and ceiling rod locations from side wall according to shop drawings. (NOTE: anchors will be 3/4" from edge of pilaster)
- Mark wall bracket holes using brackets as templates.

3 WALL BRACKETS AND FLOOR BRACKETS



7 SECURING PILASTERS AND PANELS

Pilasters must be both plumb and level. When erecting multi-compartment installations adjustments should start with center compartments.

- Level each pilaster by adjusting support nuts to desired position.
- Plumb each pilaster and fasten the pilaster to panel.
- Establish door openings by setting pilaster mounting bar to desired position on threaded rods.
- Tighten locking nuts on top of pilaster mounting bars.
- Fasten panel to wall brackets using through bolts with barrel nuts.
- Remove panel support device.

5 PILASTER PREPARATION

- Align "U" brackets in position on rear of pilasters. Refer to layout drawing.
- Fasten "U" brackets to pilasters with screws.
- Pilasters at wall do not require "U" brackets, but should be prepared for wall (and floor fastening) as required by layout.

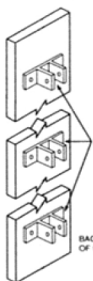

6 INSTALL PILASTERS

- Slide shoes onto pilaster.
- Thread support nuts and mounting washers over threaded rods to support pilaster mounting bar.
- At the floor position pilaster and mounting bar on wedge anchors and attach lightly with square flat washer, lockwasher and locking nut.

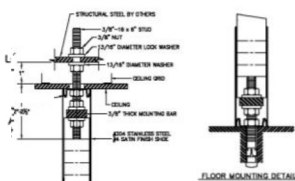

FLOOR MOUNTING DETAIL

9 SLIDE LATCH ASSEMBLY

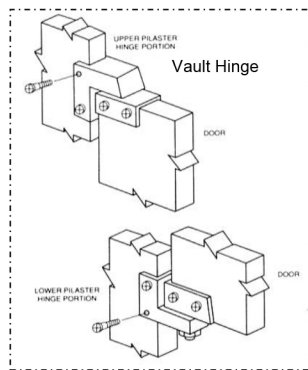
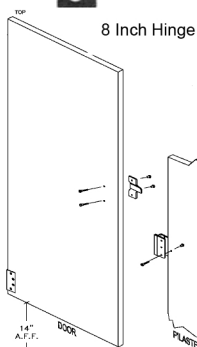

11 CARE AND MAINTENANCE OF TOILET PARTITIONS

In order to provide toilet partitions with the proper care and maintenance, the following instructions must be followed:

- All surfaces must be kept clean with water and a mild soap solution only.

WARNING

Under no circumstances should these components be subjected to:
 * Abrasive powders or pads * Water closet cleaners * Ceramic tile cleaners
 * Solutions containing more than 1% by volume of ammonia
 * Solutions containing acids or lye * Solutions containing enzymes

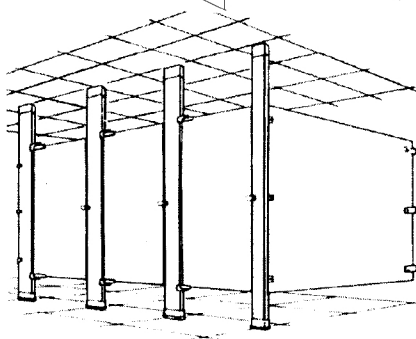

Before proceeding confirm that backing of walls and floor is adequate to support secure mounting of the toilet compartment units.

- Drill holes for wall brackets and floor fastenings of appropriate size for particular fastening devices supplied.
- Insert anchoring devices in walls and secure wall brackets.
- Install wedge anchor, washer and nut into concrete floor and tighten.

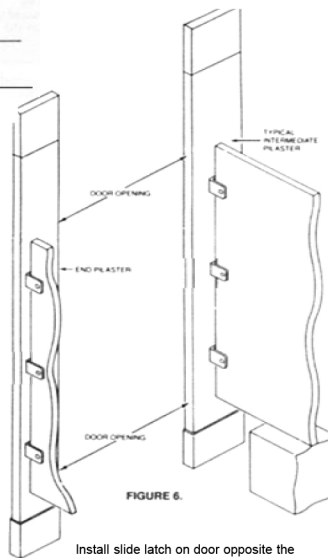

FIGURE 6.

Install slide latch on door opposite the hinge side of the door. All slide latches should be mounted at mid-point of the door.

Inswing Doors

Mount the slide latch on to the door with step bolts and barrel nuts. Install keeper and bumper on pilaster. Be sure that the keeper and bumper is set so that the slide bar of the slide latch engages the top notch of the keeper. Install keeper/bumper with step bolts and barrel nuts.

Outswing Doors

Mount the slide latch onto the door. install the stop and keeper on the pilaster. Be sure that the keeper is set so that the slide latch bar is only 1/4 inch below the top edge of the keeper.

Emergency Access

Lift door causing latch bolt to clear keeper and open.

12 INSTALLATION PILASTER SHOES

Stainless Steel Shoe

- Slide shoes over anchorings.
- Attach using vandal resistant screw.

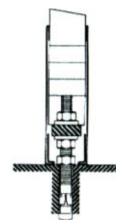
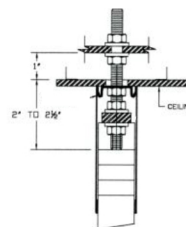

FLOOR ANCHOR DETAIL

Attention to work progress during new construction or renovation is important. Other trades and cleaning services may use agents for ceramics and tiles that will damage these components.

INSTALLATION / SOLID PLASTIC (HDPE)



CEILING HUNG

1 INSPECTION

The components for this project have been custom fabricated. They are guaranteed with respect to manufacture and workmanship and were inspected at the factory. Before beginning work, the units should be inspected. If damage occurred in transit, report immediately to the freight company or other agencies that may have caused the damage.

4 POSITION PANEL

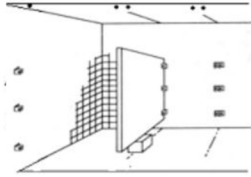

- Place panel on a support 14" above the floor.
- Set it into wall brackets but do not fasten panel at this time.

8 DOOR ASSEMBLY AND HANGING

8 Inch Hinge

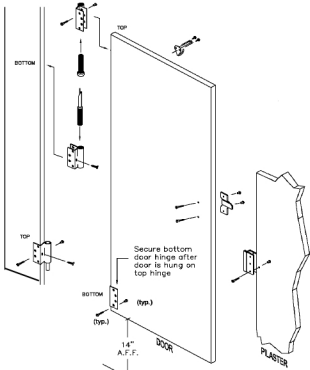

10 MISCELLANEOUS HARDWARE

- Install door bumper (and hook) in proper position.

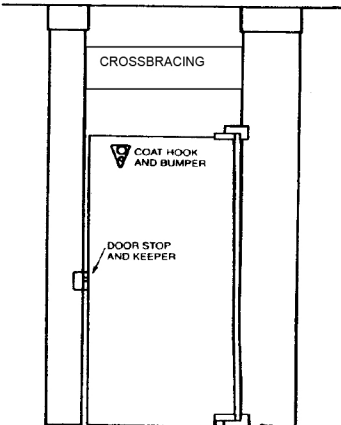
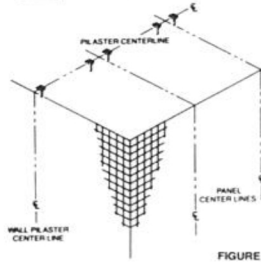

FIGURE 12.

2 LAYOUT



STRUCTURAL SUPPORT BY OTHERS

- Review the layout drawing and package lists that have accompanied this job.
- Before proceeding, confirm that the wall and ceiling is adequate to support secure mounting of toilet compartment units.
- Confirm correct location and condition of threaded ceiling rods. These should project 2" to 2-1/2" below the ceiling.
- Establish and mark pilaster and panel center lines in relation to ceiling rod locations.
- Mark wall bracket holes using brackets as templates.

5 PILASTER PREPARATION

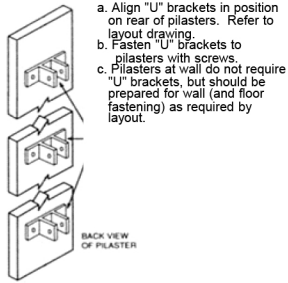

- Align "U" brackets in position on rear of pilasters. Refer to layout drawing.
- Fasten "U" brackets to pilasters with screws.
- Pilasters at wall do not require "U" brackets, but should be prepared for wall (and floor fastening) as required by layout.

6 INSTALL PILASTERS

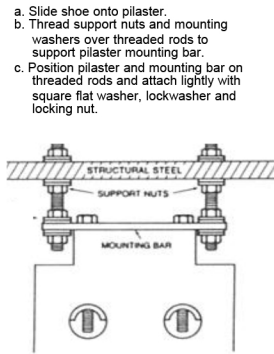

- Slide shoe onto pilaster.
- Thread support nuts and mounting washers over threaded rods to support pilaster mounting bar.
- Position pilaster and mounting bar on threaded rods and attach lightly with square flat washer, lockwasher and locking nut.

3 WALL BRACKETS AND FLOOR BRACKETS

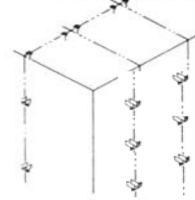

Before proceeding confirm that backing of walls and ceiling is adequate to support secure mounting of the toilet compartment units.

- Drill holes for wall brackets of appropriate size for particular fastening devices supplied.
- Insert anchoring devices in walls and secure wall brackets.
- Pilaster at wall should be prepared for wall and ceiling fastening as required by compartment layout. If ceiling fastening is omitted, use three wall brackets.

7 SECURING PILASTERS AND PANELS

Pilasters must be both plumb and level. When erecting multi-compartment installations adjustments should start with center compartments.

- Level each pilaster by adjusting both support nuts to desired position.
- Plumb each pilaster and fasten the pilaster to panel.
- Establish door openings by setting pilaster mounting bar to desired position on threaded rods.
- Tighten locking nuts on top of pilaster mounting bars.
- Fasten panel to wall brackets using through bolts with barrel nuts.
- Remove panel support device.

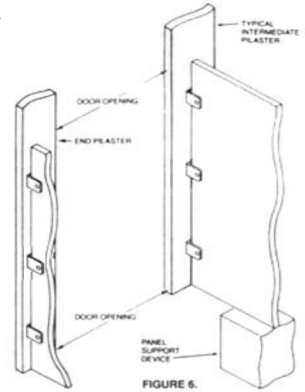
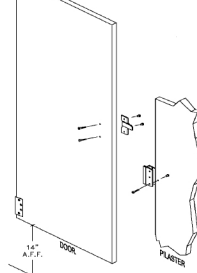

FIGURE 5.

9 SLIDE LATCH ASSEMBLY

8 Inch Hinge



Install slide latch on door opposite the hinge side of the door. All slide latches should be mounted at mid-point of the door.

Inswing Doors
Mount the slide latch on to the door with step bolts and barrel nuts. Install keeper and bumper on pilaster. Be sure that the keeper and bumper is set so that the slide bar of the slide latch engages the top notch of the keeper. Install keeper/bumper with two step bolts and two barrel nuts.

Outswing Doors
Mount the slide latch onto the door. Install the stop and keeper on the pilaster. Be sure that the keeper is set so that the slide latch bar is only 1/4 inch below the top edge of the keeper.

Emergency Access
Lift door causing latch bolt to clear keeper and open.

11 CARE AND MAINTENANCE OF TOILET PARTITIONS

In order to provide toilet partitions with the proper care and maintenance, the following instructions must be followed:

- All surfaces must be kept clean with water and a mild soap solution only.

WARNING

Under no circumstances should these components be subjected to:
 * Abrasive powders or pads * Water closet cleaners * Ceramic tile cleaners
 * Solutions containing more than 1% by volume of ammonia
 * Solutions containing acids or lye * Solutions containing enzymes

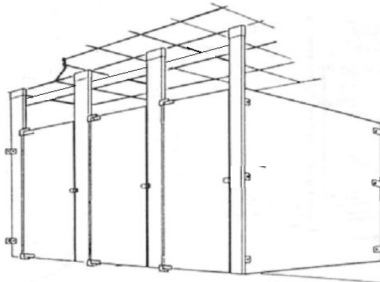

12 INSTALLATION PILASTER SHOES

Stainless Steel Shoe

- Slide shoe over anchoring.
- Attach using vandal resistant screw.

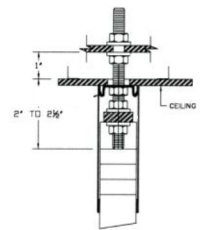

Attention to work progress during new construction or renovation is important. Other trades and cleaning services may use agents for ceramics and tiles that will damage these components.

Distributed by
 www.AmerProducts.com
 Phone: (800) 608-6548
 Fax: (407) 840-3543
 info@amerproducts.com