

FLOOR TO CEILING

1 INSPECTION

The components for this project have been custom fabricated. They are guaranteed with respect to manufacture and workmanship and were inspected at the factory. Before beginning work, the units should be inspected. If damage occurred in transit, report immediately to the freight company or other agencies that may have caused the damage.

4 POSITION PANEL

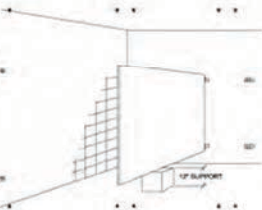

- Place panel on a support 12" above the floor.
- Set it into wall brackets but do not fasten panel at this time.

8 DOOR ASSEMBLY AND HANGING

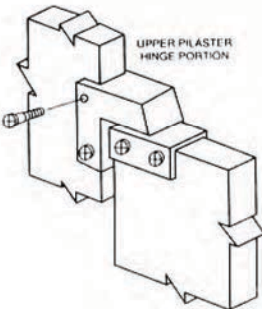

10 MISCELLANEOUS HARDWARE

- Install door bumper (and hook) in proper position.

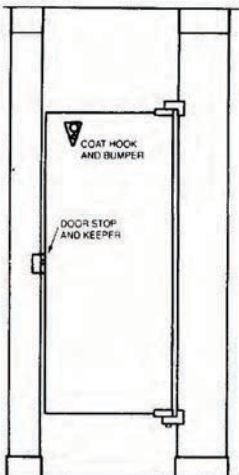

2 LAYOUT

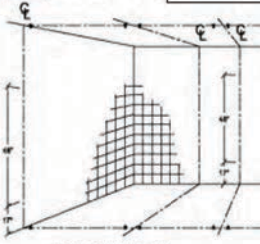

NOTE: FLOOR MUST BE CONCRETE

- Review the layout drawings and package lists that have accompanied this job.
- Establish and mark pilaster center line from back wall.
- Establish and mark panel center lines for wall brackets.
- Establish pilaster floor anchor locations from side wall according to shop drawings. (NOTE: anchors will be 3/4" from edge of pilaster)
- Mark wall bracket holes using brackets as templates.

5 PILASTER PREPARATION

- Align "U" brackets in position on rear of pilasters. Refer to layout drawing.
- Fasten "U" brackets to pilasters with screws.
- Pilasters at wall do not require "U" brackets, but should be prepared for wall (and floor fastening) as required by layout.

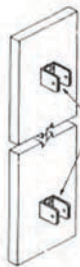
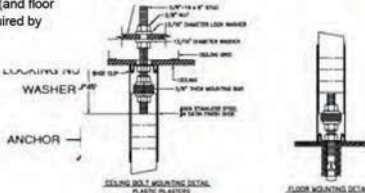

FIGURE 4. BACK VIEW OF PILASTER

6 INSTALL PILASTERS

- Slide shoes onto pilaster.
- Thread support nuts and mounting washers over threaded rods to support pilaster mounting bar.
- At the floor position pilaster and mounting bar on wedge anchors and attach lightly with square flat washer, lockwasher and locking nut.



7 SECURING PILASTERS AND PANELS

Pilasters must be both plumb and level. When erecting multi-compartment installations adjustments should start with center compartments.

- Level each pilaster by adjusting support nuts to desired position.
- Plumb each pilaster and fasten the pilaster to panel.
- Establish door openings by setting pilaster mounting bar to desired position on threaded rods.
- Tighten locking nuts on top of pilaster mounting bars.
- Fasten panel to wall brackets using through bolts with barrel nuts.
- Remove panel support device.

9 SLIDE LATCH ASSEMBLY



Install slide latch on door opposite the hinge side of the door. All slide latches should be mounted at mid-point of the door.

Inswing Doors

Mount the slide latch on to the door with step bolts and barrel nuts. Install keeper and bumper on pilaster. Be sure that the keeper and bumper is set so that the slide bar of the slide latch engages the top notch of the keeper. Install keeper/bumper with two step bolts and two barrel nuts.

Outswing Doors

Mount the slide latch onto the door. Install the stop and keeper on the pilaster. Be sure that the keeper is set so that the slide latch bar is only 1/4 inch below the top edge of the keeper.

Emergency Access

Lift door causing latch bolt to clear keeper and open.

11 CARE AND MAINTENANCE OF TOILET PARTITIONS

In order to provide toilet partitions with the proper care and maintenance, the following instructions must be followed:

- All surfaces must be kept clean with water and a mild soap solution only.

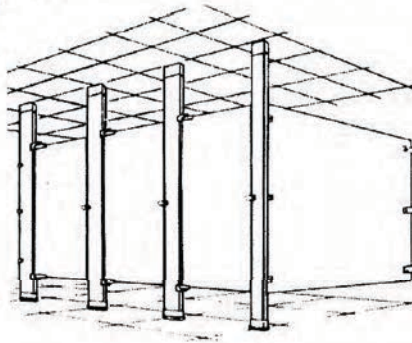

WARNING

Under no circumstances should these components be subjected to:
 * Abrasive powders or pads * Water closet cleaners * Ceramic tile cleaners
 * Solutions containing more than 1% by volume of ammonia
 * Solutions containing acids or lye * Solutions containing enzymes

12 INSTALLATION PILASTER SHOES

Stainless Steel Shoe

- Slide shoe over anchoring.
- Attach using vandal resistant screw.

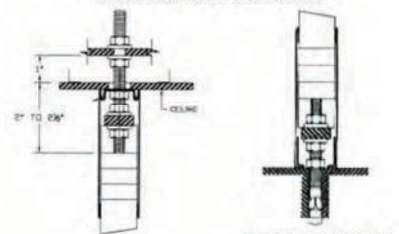

FLOOR ANCHOR DETAIL

Attention to work progress during new construction or renovation is important. Other trades and cleaning services may use agents for ceramics and tiles that will damage these components.

OVERHEAD BRACED

1 INSPECTION

The components for this project have been custom fabricated. They are guaranteed with respect to manufacture and workmanship and were inspected at the factory. Before beginning work, the units should be inspected. If damage occurred in transit, report immediately to the freight company or other agencies that may have caused the damage.

2 LAYOUT

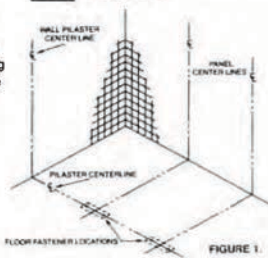

FIGURE 1.

- Review the layout drawings and package lists that have accompanied this job.
- Establish and mark pilaster center line from back wall.
- Establish and mark panel center lines for wall brackets.
- Establish pilaster floor anchor locations from side wall according to shop drawings. (NOTE: anchors will be located 3/4" from edge of pilaster)
- Mark wall bracket holes using brackets as templates.

3 WALL BRACKETS AND FLOOR BRACKETS



FIGURE 2.

NOTE: FLOOR MUST BE CONCRETE

- Before proceeding confirm that backing of walls and floor is adequate to support secure mounting of the toilet compartment units.
- Drill holes for wall brackets and floor fastenings of appropriate size for particular fastening devices supplied.
 - Insert anchoring devices in walls and secure wall brackets.
 - Install wedge anchor, washer and nut into concrete floor and tighten.

4 POSITION PANEL

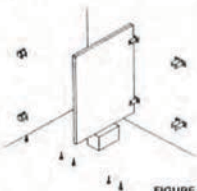

FIGURE 3.

- Place panel on a support 12" above the floor.
- Set it into wall brackets but do not fasten panel at this time.

5 PILASTER PREPARATION

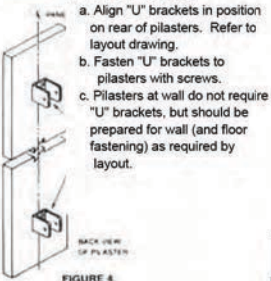
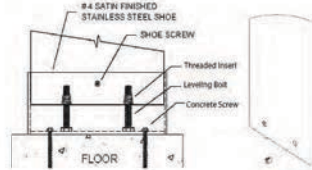

FIGURE 4.

- Align "U" brackets in position on rear of pilasters. Refer to layout drawing.
- Fasten "U" brackets to pilasters with screws.
- Pilasters at wall do not require "U" brackets, but should be prepared for wall (and floor fastening) as required by layout.

6 INSTALL PILASTERS

- Insert the leveling bolt into the threaded insert at bottom of pilaster
 - Insert the pilaster into the shoe
 - Level the top of all pilasters by adjusting the leveling bolt to desired position
- Note: To determine how far to insert the leveling bolt, find the highest point on the floor, and fully insert the bolt on the pilaster that will be mounted in that location. Adjust all other leveling bolts accordingly.



10 SLIDE LATCH ASSEMBLY

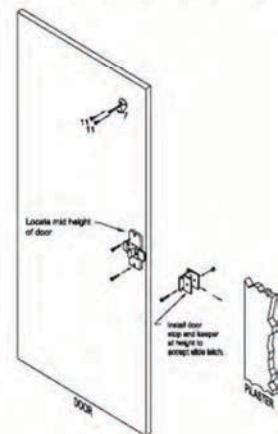

Install slide latch on door opposite the hinge side of the door. All slide latches should be mounted at mid-point of the door.

Inswing Doors
Mount the slide latch on to the door with step bolts and barrel nuts. Install keeper and bumper on pilaster. Be sure that the keeper and bumper is set so that the slide bar of the slide latch engages the top notch of the keeper. Install keeper/bumper with two step bolts and two barrel nuts.

Outswing Doors
Mount the slide latch onto the door. install the stop and keeper on the pilaster. Be sure that the keeper is set so that the slide latch bar is only 1/4 inch below the top edge of the keeper.

Emergency Access
Lift door causing latch bolt to clear keeper and open.

9 DOOR ASSEMBLY AND HANGING

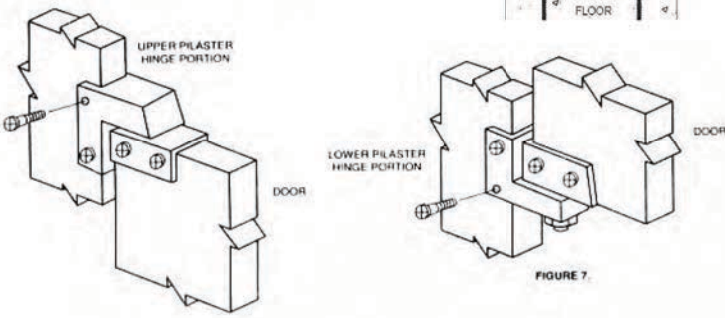

FIGURE 7.

11 MISCELLANEOUS HARDWARE

- Install door bumper (and hook) in proper position.

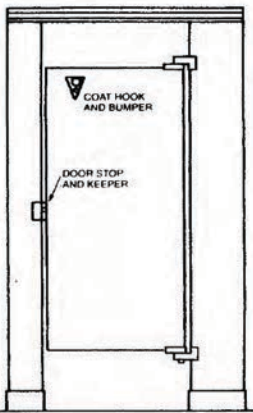

FIGURE 12.

12 CARE AND MAINTENANCE OF TOILET PARTITIONS

In order provide toilet partitions with the proper care and maintenance, the following instructions must be followed.

- All surfaces must be kept clean with water and a mild soap solution only. The finish must be wiped dry following cleaning.

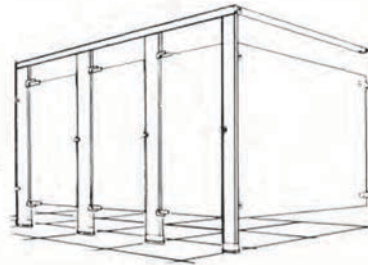
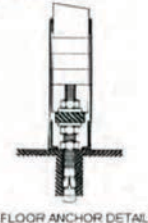

FIGURE 13.

WARNING
Under no circumstances should these components be subjected to:
* Abrasive powders or pads * Water closet cleaners * Ceramic tile cleaners
* Solutions containing more than 1% by volume of ammonia
* Solutions containing acids or lye * Solutions containing enzymes

13 INSTALLATION PILASTER SHOES

- Stainless Steel Shoe**
- Slide shoe over anchoring.
 - Attach using vandal resistant screw.



FLOOR ANCHOR DETAIL

Attention to work progress during new construction or renovation is important. Other trades and cleaning services may use agents for ceramics and tiles that will damage these components.

Distributed by
www.Ameraproducts.com
Phone: (800) 608-6568
FAX: (409) 840-5542
info@ameraproducts.com

FLOOR MOUNTED

1 INSPECTION

The components for this project have been custom fabricated. They are guaranteed with respect to manufacture and workmanship and were inspected at the factory. Before beginning work, the units should be inspected. If damage occurred in transit, report immediately to the freight company or other agencies that may have caused the damage.

4 POSITION PANEL

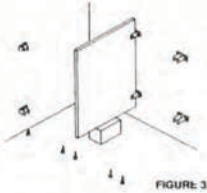
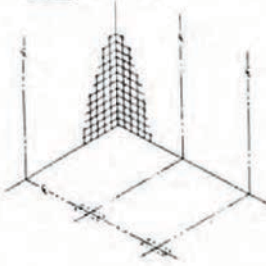

FIGURE 3

- Place panel on a support 12" above the floor.
- Set it into wall brackets but do not fasten panel at this time.

2 LAYOUT



NOTE: FLOOR MUST BE CONCRETE

- Review the layout drawings and package lists that have accompanied this job.
- Establish and mark pilaster center line from back wall.
- Establish and mark panel center lines for wall brackets.
- Establish pilaster floor anchor locations from side wall according to shop drawings. (NOTE: anchors will be located 3/4" from edge of pilaster)
- Mark wall bracket holes using brackets as templates.

5 PILASTER PREPARATION

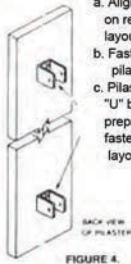

FIGURE 4

- Align "U" brackets in position on rear of pilasters. Refer to layout drawing.
- Fasten "U" brackets to pilasters with screws.
- Pilasters at wall do not require "U" brackets, but should be prepared for wall (and floor fastening) as required by layout.

6 INSTALL PILASTERS

- Slide shoe onto pilaster.
- Thread support nuts and mounting washers over threaded rods to support pilaster mounting bar.
- At the floor position pilaster and mounting bar on wedge anchors and attach lightly with square flat washer, lockwasher and lock-nut nut.

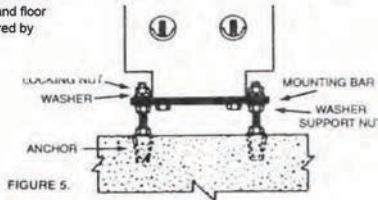

FIGURE 5

3 WALL BRACKETS AND FLOOR BRACKETS



FIGURE 2

Before proceeding confirm that backing of walls and floor is adequate to support secure mounting of the toilet compartment units.

- Drill holes for wall brackets and floor fastenings of appropriate size for particular fastening devices supplied.
- Insert anchoring devices in walls and secure wall brackets.
- Install wedge anchor, washer and nut into concrete floor and tighten.

7 SECURING PILASTERS TO PANELS

Pilasters must be both plumb and level.

- Plumb pilaster and fasten pilaster to panel using through bolts with barrel nuts.
- Establish bottom door openings by setting pilaster mounting to desired position.

8 SECURING PANEL

- Tighten locking nuts on top of pilaster mounting bars.
- Fasten panel to wall brackets using through bolts with barrel nuts.
- Remove panel support device.

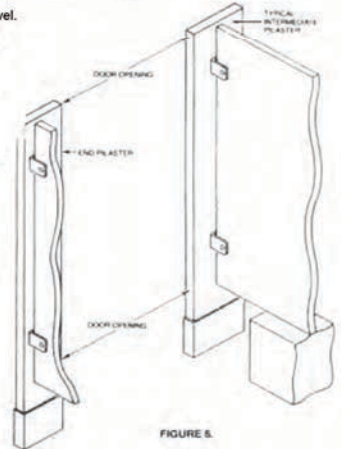
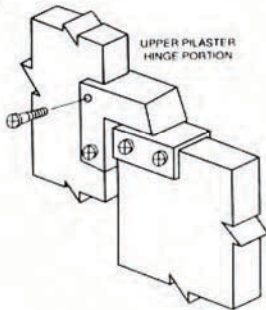
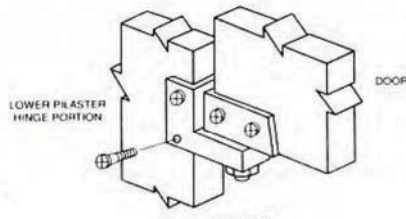

FIGURE 6

9 DOOR ASSEMBLY AND HANGING



DOOR



DOOR

FIGURE 7

10 SLIDE LATCH ASSEMBLY

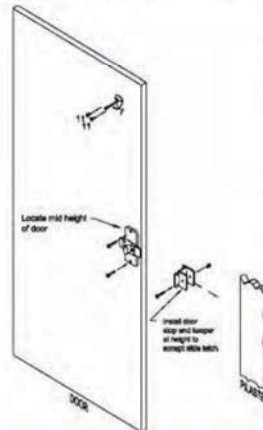

Install slide latch on door opposite the hinge side of the door. All slide latches should be mounted at mid-point of the door.

Inswing Doors
Mount the slide latch on to the door with step bolts and barrel nuts. Install keeper and bumper on pilaster. Be sure that the keeper and bumper is set so that the slide bar of the slide latch engages the top notch of the keeper. Install keeper/bumper with two step bolts and two barrel nuts.

Outswing Doors
Mount the slide latch onto the door. Install the stop and keeper on the pilaster. Be sure that the keeper is set so that the slide latch bar is only 1/4 inch below the top edge of the keeper.

Emergency Access
Lift door causing latch bolt to clear keeper and open.

11 MISCELLANEOUS HARDWARE

- Install door bumper (and hook) in proper position.

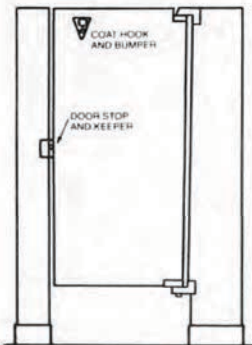

FIGURE 12

12 CARE AND MAINTENANCE OF TOILET PARTITIONS

In order provide toilet partitions with the proper care and maintenance, the following instructions must be followed.

- All surfaces must be kept clean with water and a mild soap solution only. The finish must be wiped dry following cleaning.

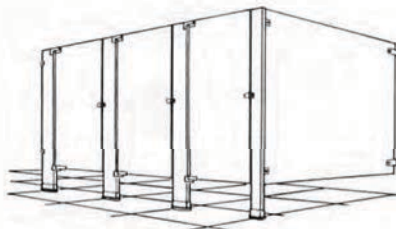

FIGURE 13

WARNING

Under no circumstances should these components be subjected to:
 * Abrasive powders or pads * Water closet cleaners * Ceramic tile cleaners
 * Solutions containing more than 1% by volume of ammonia
 * Solutions containing acids or lye * Solutions containing enzymes

13 INSTALLATION PILASTER SHOES

Stainless Steel Shoe

- Slide shoe over anchoring.
- Attach using vandal resistant screw.

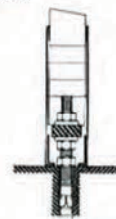

FLOOR ANCHOR DETAIL

Attention to work progress during new construction or renovation is important. Other trades and cleaning services may use agents for ceramics and tiles that will damage these components.

Distributed by
 www.Ameraproducts.com
 Phone: (800) 608-6548
 FAX: (409) 840-3542
 info@ameraproducts.com

CEILING HUNG

1 INSPECTION

The components for this project have been custom fabricated. They are guaranteed with respect to manufacture and workmanship and were inspected at the factory. Before beginning work, the units should be inspected. If damage occurred in transit, report immediately to the freight company or other agencies that may have caused the damage.

4 POSITION PANEL

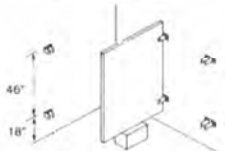

FIGURE 3.

- Place panel on a support 12" above the floor.
- Set it into wall brackets but do not fasten panel at this time.

8 DOOR ASSEMBLY AND HANGING

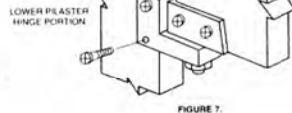
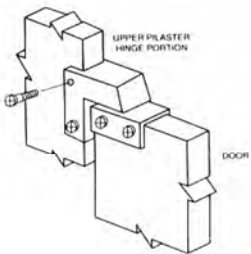

FIGURE 7.

10 MISCELLANEOUS HARDWARE

- Install door bumper (and hook) in proper position.

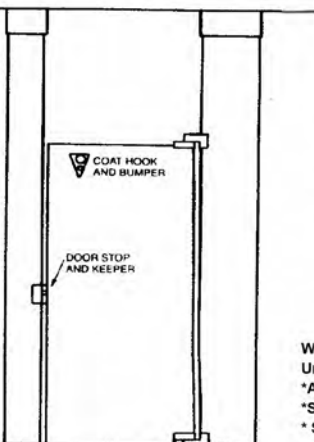

FIGURE 12.

2 LAYOUT STRUCTURAL SUPPORT BY OTHERS

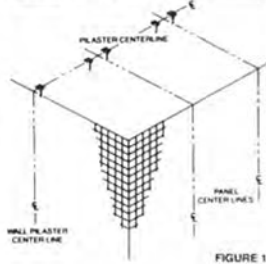

FIGURE 1.

- Review the layout drawing and package lists that have accompanied this job.
- Before proceeding, confirm that the wall and ceiling is adequate to support secure mounting of toilet compartment units.
- Confirm correct location and condition of threaded ceiling rods. These should project 2" to 2-1/2" below the ceiling.
- Establish and mark pilaster and panel center lines in relation to ceiling rod locations.
- Mark wall bracket holes using brackets as templates.

5 PILASTER PREPARATION

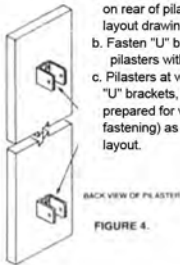

FIGURE 4.

- Align "U" brackets in position on rear of pilasters. Refer to layout drawing.
- Fasten "U" brackets to pilasters with screws.
- Pilasters at wall do not require "U" brackets, but should be prepared for wall (and floor fastening) as required by layout.

6 INSTALL PILASTERS

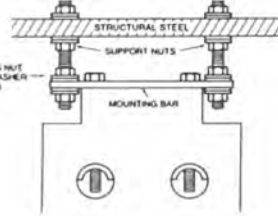

FIGURE 5.

- Slide shoe onto pilaster.
- Thread support nuts and mounting washers over threaded rods to support pilaster mounting bar.
- Position pilaster and mounting bar on threaded rods and attach lightly with square flat washer, lockwasher and locking nut.

3 WALL BRACKETS AND FLOOR BRACKETS

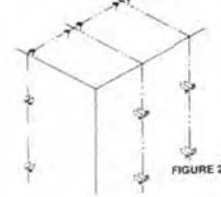

FIGURE 2.

Before proceeding confirm that backing of walls and ceiling is adequate to support secure mounting of the toilet compartment units.

- Drill holes for wall brackets and floor fastenings of appropriate size for particular fastening devices supplied.
- Insert anchoring devices in walls and secure wall brackets.
- Pilaster at wall should be prepared for wall and ceiling fastening as required by compartment layout. If ceiling fastening is omitted, use three wall brackets.

7 SECURING PILASTERS AND PANELS

Pilasters must be both plumb and level. When erecting multi-compartment installations adjustments should start with center compartments.

- Level each pilaster by adjusting both support nuts to desired position.
- Plumb each pilaster and fasten the pilaster to panel.
- Establish door openings by setting pilaster mounting bar to desired position on threaded rods.
- Tighten locking nuts on top of pilaster mounting bars.
- Fasten panel to wall brackets using through bolts with barrel nuts.
- Remove panel support device.

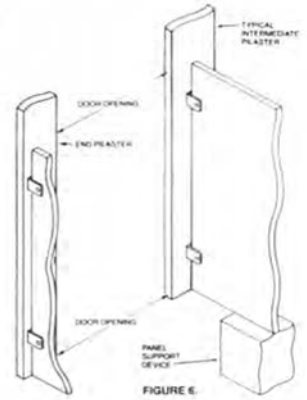
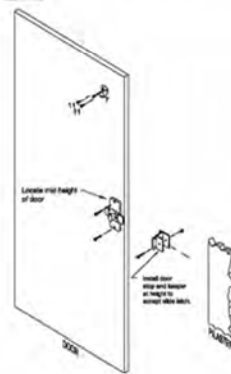

FIGURE 6.

9 SLIDE LATCH ASSEMBLY



Install slide latch on door opposite the hinge side of the door. All slide latches should be mounted at mid-point of the door.

Inswing Doors

Mount the slide latch on to the door with step bolts and barrel nuts. Install keeper and bumper on pilaster. Be sure that the keeper and bumper is set so that the slide bar of the slide latch engages the top notch of the keeper. Install keeper/bumper with two step bolts and two barrel nuts.

Outswing Doors

Mount the slide latch onto the door. Install the stop and keeper on the pilaster. Be sure that the keeper is set so that the slide latch bar is only 1/4 inch below the top edge of the keeper.

Emergency Access

Lift door causing latch bolt to clear keeper and open.

11 CARE AND MAINTENANCE OF TOILET PARTITIONS

In order to provide toilet partitions with the proper care and maintenance, the following instructions must be followed:

- All surfaces must be kept clean with water and a mild soap solution only.
- Water left on units for extended periods will damage surface. The finish must be wiped dry following cleaning.
- In high humidity areas the rooms must be properly ventilated.
- "Hosing down" or wet washing of these units may cause water absorption and damage.
- For maximum protection, periodic application of any standard furniture wax will be beneficial.

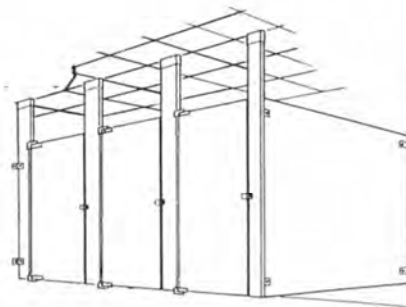

WARNING

Under no circumstances should these components be subjected to:
 *Abrasive powders or pads * Water closet cleaners * Ceramic tile cleaners
 *Solutions containing more than 1% by volume of ammonia
 * Solutions containing acids or lye * Solutions containing enzymes

12 INSTALLATION PILASTER SHOES

Stainless Steel Shoe

- Slide shoe over anchoring.
- Attach using vandal resistant screw.

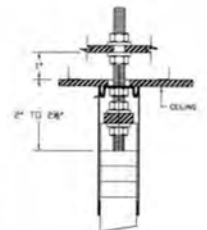

Attention to work progress during new construction or renovation is important. Other trades and cleaning services may use agents for ceramics and tiles that will damage these components.